

Installation and Operation Instruction

The **FlowCon Partner Globe** is available in six different flanged sizes:

- FlowCon Partner Globe DN65-300 (2"-12").

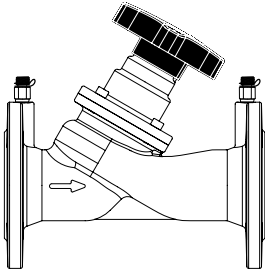

Figure 1

Installation

Prior to installing the FlowCon Partner Globe (supplied from factory in setting 0.0 due to calibration), the system should be properly flushed. Remember to remove dust caps if valves are provided with such.

Setting

After installation, setting is done by turning the hand wheel (turned from setting 0.0 and up) - no tools required. Scale setting is located on top of the hand wheel where the outer digits ❶, numbered 1 to 8 (DN65-150 / 2 1/2"-6") or 1 to 11 (DN200-300 / 8"-12"), indicate full turns and the inner digit ❷, numbered 0 to 9, indicates 1/10 of

full turn. Clockwise turning will reduce flow and counter-clockwise turning will increase flow.

Capillary tube

Capillary tube is as standard supplied with the DPCV valve along with required 1/4" NPT to 1/4" ISO adaptor. Do not damage the capillary tube by compressing or bending the tube with a bending radius below 20 mm (3/4"). Capillary tube is to be finger mounted in the outlet body tapping of the FlowCon Partner Globe instead of the supplied p/t plug and tightened with 1-3Nm - **DO NOT OVER TIGHTEN.**

Locking

1. Remove the top wheel cap ❸ with e.g. a flat screwdriver.
2. Close the valve completely by turning the hand wheel clockwise till fully closed. Check the scale to be 0.0.
3. Open to required position by turning counter-clockwise.
4. Turn clockwise and fully tighten the lock screw ❹ with a 5 mm (1/5") Allen key, valve setting is now locked to current setting.
5. Return the wheel cap and click it in place.

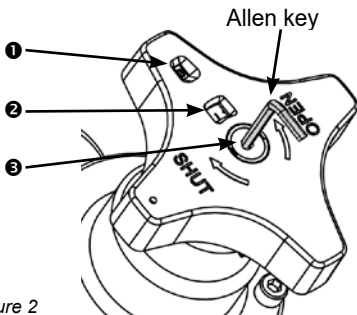
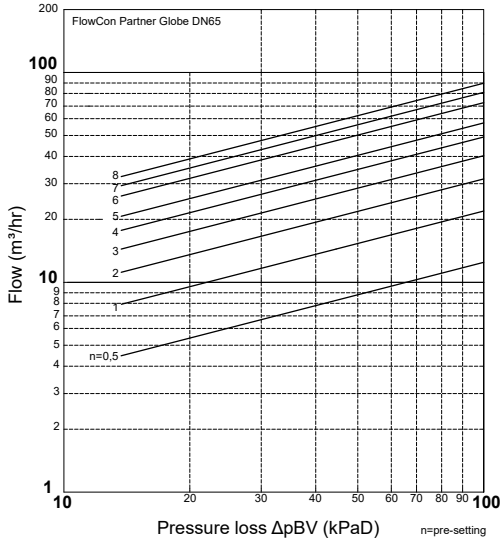
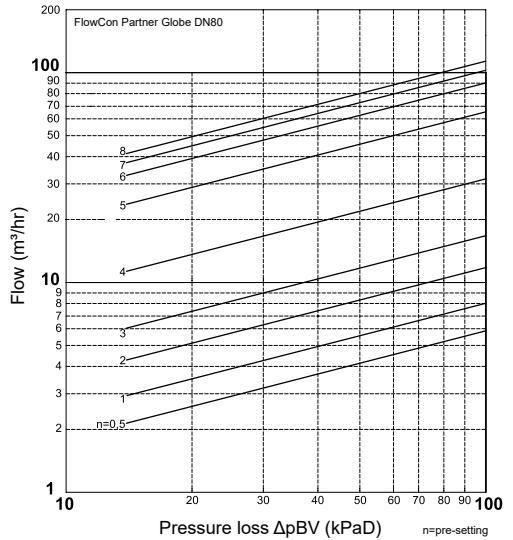

Figure 2

FlowCon Partner Globe DN65



FlowCon Partner Globe DN80



FlowCon Partner Globe DN65					
Turn	Kv (m³/hr)	Turn	Kv (m³/hr)	Turn	Kv (m³/hr)
0.5	12.5	3.3	42.6	5.7	67.6
1.0	21.9	3.4	43.5	5.8	69.1
1.1	22.9	3.5	44.4	5.9	70.5
1.2	23.9	3.6	45.4	6.0	71.8
1.3	24.7	3.7	46.4	6.1	72.9
1.4	25.6	3.8	47.4	6.2	73.9
1.5	26.4	3.9	48.4	6.3	74.9
1.6	27.3	4.0	49.3	6.4	75.8
1.7	28.3	4.1	50.1	6.5	76.6
1.8	29.2	4.2	50.9	6.6	77.4
1.9	30.1	4.3	51.7	6.7	78.2
2.0	31.1	4.4	52.5	6.8	78.9
2.1	32.0	4.5	53.2	6.9	79.6
2.2	33.0	4.6	54.0	7.0	80.4
2.3	33.9	4.7	54.8	7.1	81.1
2.4	34.8	4.8	55.6	7.2	81.8
2.5	35.7	4.9	56.5	7.3	82.6
2.6	36.6	5.0	57.5	7.4	83.3
2.7	37.5	5.1	58.6	7.5	84.1
2.8	38.4	5.2	59.9	7.6	84.9
2.9	39.3	5.3	61.3	7.7	85.8
3.0	40.1	5.4	62.8	7.8	86.7
3.1	41.0	5.5	64.4	7.9	87.7
3.2	41.8	5.6	66.0	8.0	88.8

FlowCon Partner Globe DN80					
Turn	Kv (m³/hr)	Turn	Kv (m³/hr)	Turn	Kv (m³/hr)
0.5	5.9	3.3	19.4	5.7	83.8
1.0	7.9	3.4	20.6	5.8	85.8
1.1	8.4	3.5	21.9	5.9	87.6
1.2	8.7	3.6	23.4	6.0	89.3
1.3	9.1	3.7	25.0	6.1	90.9
1.4	9.5	3.8	26.9	6.2	92.5
1.5	9.9	3.9	28.9	6.3	93.9
1.6	10.3	4.0	31.2	6.4	95.3
1.7	10.7	4.1	33.6	6.5	96.6
1.8	11.0	4.2	36.3	6.6	97.9
1.9	11.4	4.3	39.2	6.7	99.1
2.0	11.8	4.4	42.4	6.8	100.4
2.1	12.2	4.5	45.9	6.9	101.5
2.2	12.6	4.6	49.7	7.0	102.7
2.3	13.0	4.7	53.6	7.1	103.8
2.4	13.4	4.8	57.5	7.2	104.9
2.5	13.8	4.9	61.4	7.3	106.0
2.6	14.3	5.0	65.0	7.4	107.1
2.7	14.8	5.1	68.4	7.5	108.2
2.8	15.4	5.2	71.5	7.6	109.2
2.9	16.0	5.3	74.4	7.7	110.3
3.0	16.7	5.4	77.0	7.8	111.3
3.1	17.5	5.5	79.5	7.9	112.4
3.2	18.4	5.6	81.7	8.0	113.4

FlowCon Partner Globe 65-300 mm (2"-12")
1H95060 - 04/2019

FlowCon Partner Globe DN100

FlowCon Partner Globe DN125

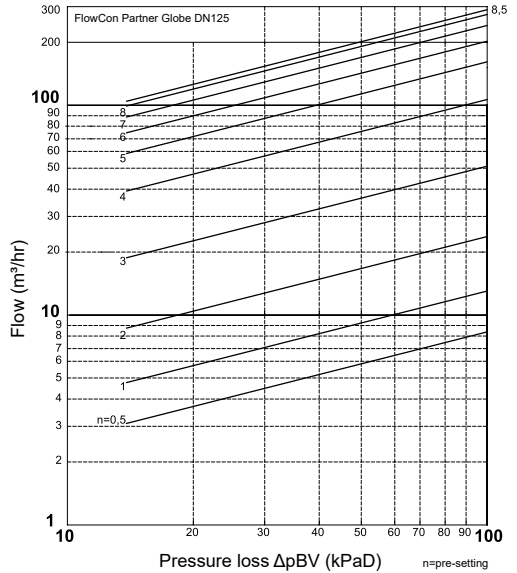
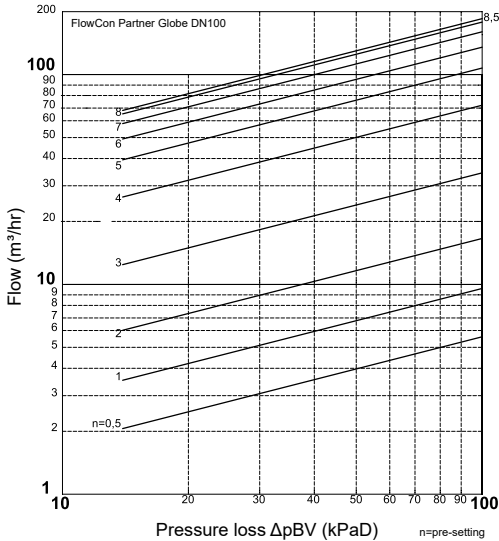

FlowCon Partner Globe DN100					
Turn	Kv (m³/hr)	Turn	Kv (m³/hr)	Turn	Kv (m³/hr)
0.5	5.6	3.5	50.5	6.1	137.6
1.0	9.6	3.6	54.4	6.2	140.3
1.1	10.2	3.7	58.6	6.3	142.9
1.2	10.9	3.8	62.8	6.4	145.5
1.3	11.5	3.9	67.1	6.5	148.1
1.4	12.1	4.0	71.4	6.6	150.6
1.5	12.8	4.1	75.5	6.7	153.0
1.6	13.4	4.2	79.6	6.8	155.4
1.7	14.1	4.3	83.5	6.9	157.7
1.8	14.9	4.4	87.3	7.0	159.9
1.9	15.7	4.5	90.9	7.1	162.0
2.0	16.6	4.6	94.5	7.2	164.1
2.1	17.5	4.7	97.9	7.3	166.0
2.2	18.7	4.8	101.2	7.4	167.9
2.3	19.9	4.9	104.4	7.5	169.8
2.4	21.3	5.0	107.4	7.6	171.5
2.5	22.9	5.1	110.4	7.7	173.2
2.6	24.7	5.2	113.3	7.8	174.8
2.7	26.7	5.3	116.1	7.9	176.4
2.8	28.9	5.4	118.9	8.0	177.9
2.9	31.3	5.5	121.6	8.1	179.4
3.0	34.0	5.6	124.3	8.2	180.8
3.1	36.9	5.7	127.0	8.3	182.1
3.2	40.0	5.8	129.6	8.4	183.4
3.3	43.3	5.9	132.3	8.5	184.7
3.4	46.8	6.0	135.0		

FlowCon Partner Globe DN125					
Turn	Kv (m³/hr)	Turn	Kv (m³/hr)	Turn	Kv (m³/hr)
0.5	8.3	3.5	77.0	6.1	205.8
1.0	13.0	3.6	82.7	6.2	209.8
1.1	13.9	3.7	88.5	6.3	213.8
1.2	14.9	3.8	94.5	6.4	217.7
1.3	15.8	3.9	100.4	6.5	221.6
1.4	16.8	4.0	106.5	6.6	225.4
1.5	17.8	4.1	112.5	6.7	229.1
1.6	18.9	4.2	118.5	6.8	232.8
1.7	19.9	4.3	124.3	6.9	236.3
1.8	21.1	4.4	130.1	7.0	239.8
1.9	22.3	4.5	135.7	7.1	243.2
2.0	23.7	4.6	141.1	7.2	246.5
2.1	25.2	4.7	146.3	7.3	249.7
2.2	26.8	4.8	151.4	7.4	252.8
2.3	28.6	4.9	156.2	7.5	255.9
2.4	30.7	5.0	160.9	7.6	259.0
2.5	33.1	5.1	165.4	7.7	262.0
2.6	35.8	5.2	169.7	7.8	264.9
2.7	38.9	5.3	173.9	7.9	267.9
2.8	42.5	5.4	178.0	8.0	270.8
2.9	46.6	5.5	182.1	8.1	273.7
3.0	51.2	5.6	186.1	8.2	276.6
3.1	56.0	5.7	190.0	8.3	279.4
3.2	61.0	5.8	194.0	8.4	282.3
3.3	66.2	5.9	197.9	8.5	285.1
3.4	71.5	6.0	201.9		

FlowCon Partner Globe 65-300 mm (2"-12")
1H95060 - 04/2019

FlowCon Partner Globe DN150

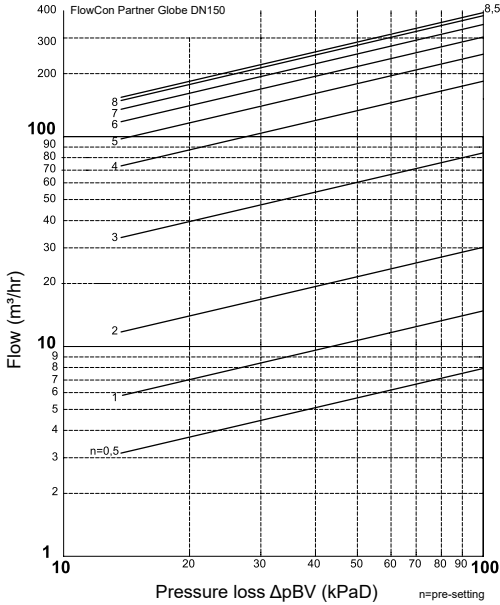

FlowCon Partner Globe DN200

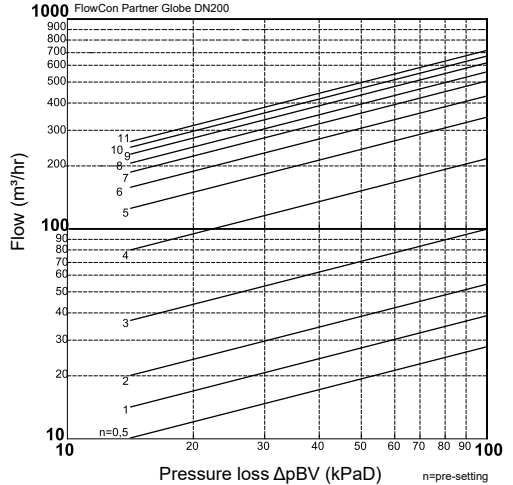

FlowCon Partner Globe DN150					
Turn	Kv (m³/hr)	Turn	Kv (m³/hr)	Turn	Kv (m³/hr)
0.5	7.9	3.5	132.0	6.1	303.0
1.0	14.8	3.6	143.1	6.2	307.7
1.1	15.6	3.7	154.0	6.3	312.3
1.2	16.3	3.8	164.6	6.4	316.9
1.3	17.1	3.9	174.5	6.5	321.3
1.4	18.0	4.0	183.7	6.6	325.7
1.5	19.1	4.1	192.0	6.7	329.9
1.6	20.5	4.2	199.6	6.8	334.1
1.7	22.1	4.3	206.7	6.9	338.2
1.8	24.2	4.4	213.3	7.0	342.2
1.9	26.7	4.5	219.5	7.1	346.1
2.0	29.7	4.6	225.3	7.2	349.9
2.1	33.2	4.7	231.0	7.3	353.6
2.2	37.2	4.8	236.5	7.4	357.2
2.3	41.7	4.9	241.8	7.5	360.7
2.4	46.5	5.0	247.1	7.6	364.2
2.5	51.8	5.1	252.4	7.7	367.5
2.6	57.4	5.2	257.7	7.8	370.7
2.7	63.4	5.3	262.9	7.9	373.8
2.8	69.7	5.4	268.1	8.0	376.8
2.9	76.4	5.5	273.3	8.1	379.7
3.0	83.7	5.6	278.4	8.2	382.5
3.1	91.7	5.7	283.5	8.3	385.2
3.2	100.7	5.8	288.4	8.4	387.7
3.3	110.5	5.9	293.4	8.5	390.2
3.4	121.1	6.0	298.2		

FlowCon Partner Globe DN200							
Turn	Kv (m³/hr)	Turn	Kv (m³/hr)	Turn	Kv (m³/hr)	Turn	Kv (m³/hr)
0.5	27.5	3.5	148.6	6.1	438.5	8.7	602.0
1.0	38.6	3.6	161.0	6.2	447.0	8.8	607.9
1.1	40.1	3.7	174.2	6.3	455.4	8.9	613.7
1.2	41.5	3.8	187.9	6.4	463.7	9.0	619.3
1.3	42.9	3.9	202.0	6.5	471.7	9.1	624.7
1.4	44.2	4.0	216.2	6.6	479.6	9.2	630.0
1.5	45.6	4.1	230.3	6.7	487.1	9.3	635.0
1.6	47.0	4.2	244.2	6.8	494.3	9.4	640.0
1.7	48.6	4.3	257.8	6.9	501.1	9.5	644.8
1.8	50.3	4.4	271.0	7.0	507.6	9.6	649.4
1.9	52.3	4.5	283.9	7.1	513.6	9.7	654.0
2.0	54.6	4.6	296.3	7.2	519.3	9.8	658.5
2.1	57.2	4.7	308.3	7.3	524.8	9.9	662.9
2.2	60.1	4.8	319.7	7.4	530.0	10.0	667.2
2.3	63.4	4.9	330.7	7.5	535.2	10.1	671.5
2.4	67.1	5.0	341.2	7.6	540.2	10.2	675.8
2.5	71.2	5.1	351.2	7.7	545.2	10.3	680.0
2.6	75.8	5.2	360.8	7.8	550.3	10.4	684.2
2.7	80.9	5.3	370.0	7.9	555.5	10.5	688.4
2.8	86.6	5.4	379.0	8.0	560.8	10.6	692.7
2.9	92.9	5.5	387.7	8.1	566.4	10.7	696.9
3.0	99.9	5.6	396.3	8.2	572.1	10.8	701.2
3.1	107.8	5.7	404.8	8.3	578.0	10.9	705.6
3.2	116.6	5.8	413.3	8.4	583.9	11.0	710.0
3.3	126.3	5.9	421.7	8.5	590.0		
3.4	137.0	6.0	430.1	8.6	596.0		

FlowCon Partner Globe 65-300 mm (2"-12")

1H95060 - 04/2019

FlowCon Partner Globe DN250

FlowCon Partner Globe DN300

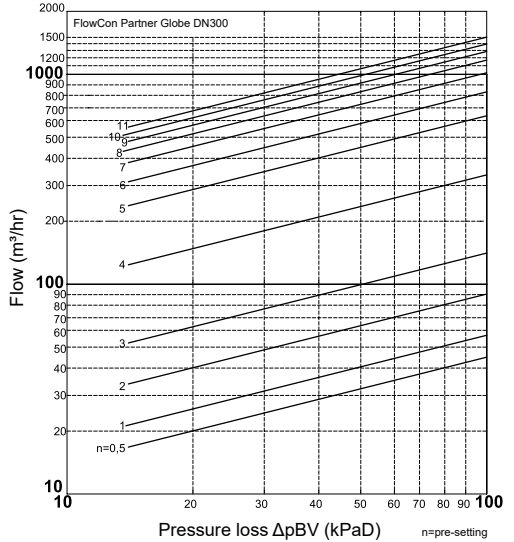
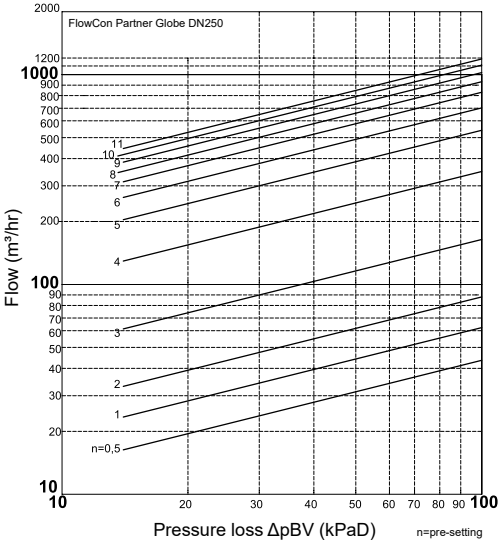

FlowCon Partner Globe DN250							
Turn	Kv (m³/hr)	Turn	Kv (m³/hr)	Turn	Kv (m³/hr)	Turn	Kv (m³/hr)
0.5	43.5	3.5	239.2	6.1	708.1	8.7	993.9
1.0	62.3	3.6	258.4	6.2	722.0	8.8	1003.5
1.1	64.7	3.7	278.9	6.3	735.7	8.9	1013.0
1.2	66.9	3.8	300.5	6.4	749.2	9.0	1022.4
1.3	69.0	3.9	322.8	6.5	762.5	9.1	1031.7
1.4	71.0	4.0	345.3	6.6	775.4	9.2	1040.9
1.5	73.1	4.1	367.4	6.7	788.1	9.3	1050.0
1.6	75.3	4.2	389.2	6.8	800.3	9.4	1058.9
1.7	77.7	4.3	410.5	6.9	812.2	9.5	1067.8
1.8	80.4	4.4	431.2	7.0	823.7	9.6	1076.5
1.9	83.6	4.5	451.4	7.1	834.8	9.7	1085.1
2.0	87.3	4.6	471.0	7.2	845.5	9.8	1093.6
2.1	91.6	4.7	489.9	7.3	856.0	9.9	1101.9
2.2	96.6	4.8	508.3	7.4	866.2	10.0	1110.2
2.3	102.3	4.9	526.1	7.5	876.3	10.1	1118.4
2.4	108.7	5.0	543.3	7.6	886.2	10.2	1126.5
2.5	115.8	5.1	559.9	7.7	896.1	10.3	1134.4
2.6	123.8	5.2	576.0	7.8	905.8	10.4	1142.3
2.7	132.5	5.3	591.7	7.9	915.6	10.5	1150.1
2.8	142.0	5.4	607.0	8.0	925.3	10.6	1157.7
2.9	152.5	5.5	622.0	8.1	935.1	10.7	1165.3
3.0	163.9	5.6	636.8	8.2	944.9	10.8	1172.8
3.1	176.4	5.7	651.3	8.3	954.8	10.9	1180.2
3.2	190.1	5.8	665.7	8.4	964.6	11.0	1187.5
3.3	205.1	5.9	679.9	8.5	974.4		
3.4	221.4	6.0	694.0	8.6	984.2		

FlowCon Partner Globe DN300							
Turn	Kv (m³/hr)	Turn	Kv (m³/hr)	Turn	Kv (m³/hr)	Turn	Kv (m³/hr)
0.5	44.9	3.5	202.0	6.1	844.2	8.7	1252.1
1.0	57.1	3.6	221.1	6.2	863.6	8.8	1263.2
1.1	59.9	3.7	243.4	6.3	883.3	8.9	1274.2
1.2	62.8	3.8	269.4	6.4	903.1	9.0	1285.1
1.3	65.9	3.9	299.1	6.5	922.9	9.1	1296.0
1.4	69.0	4.0	331.7	6.6	942.5	9.2	1306.9
1.5	72.2	4.1	365.6	6.7	962.0	9.3	1317.8
1.6	75.6	4.2	400.1	6.8	981.0	9.4	1328.7
1.7	79.0	4.3	434.4	6.9	999.7	9.5	1339.6
1.8	82.5	4.4	468.0	7.0	1017.8	9.6	1350.5
1.9	86.1	4.5	500.2	7.1	1035.3	9.7	1361.4
2.0	89.8	4.6	530.8	7.2	1052.3	9.8	1372.3
2.1	93.5	4.7	559.4	7.3	1068.7	9.9	1383.2
2.2	97.4	4.8	586.1	7.4	1084.6	10.0	1394.1
2.3	101.4	4.9	611.0	7.5	1100.0	10.1	1405.1
2.4	105.7	5.0	634.1	7.6	1114.9	10.2	1416.0
2.5	110.2	5.1	655.6	7.7	1129.3	10.3	1427.0
2.6	115.1	5.2	676.0	7.8	1143.2	10.4	1437.9
2.7	120.5	5.3	695.6	7.9	1156.7	10.5	1448.9
2.8	126.4	5.4	714.6	8.0	1169.7	10.6	1459.9
2.9	133.1	5.5	733.2	8.1	1182.3	10.7	1470.9
3.0	140.7	5.6	751.6	8.2	1194.6	10.8	1481.9
3.1	149.5	5.7	769.8	8.3	1206.5	10.9	1493.0
3.2	159.8	5.8	788.1	8.4	1218.2	11.0	1504.1
3.3	171.8	5.9	806.5	8.5	1229.7		
3.4	185.7	6.0	825.1	8.6	1241.0		

FlowCon Partner Globe 65-300 mm (2"-12")

1H95060 - 04/2019

General Assembly Drawing FlowCon Partner Globe

- A: Valve housing
- B: P/t plug (2 pcs.)
- C: Capillary tube incl. fitting and 1/4" NPT to 1/4" ISO adaptor
(supplied together with DPCV valve)
- D: Plug (2 pcs.).

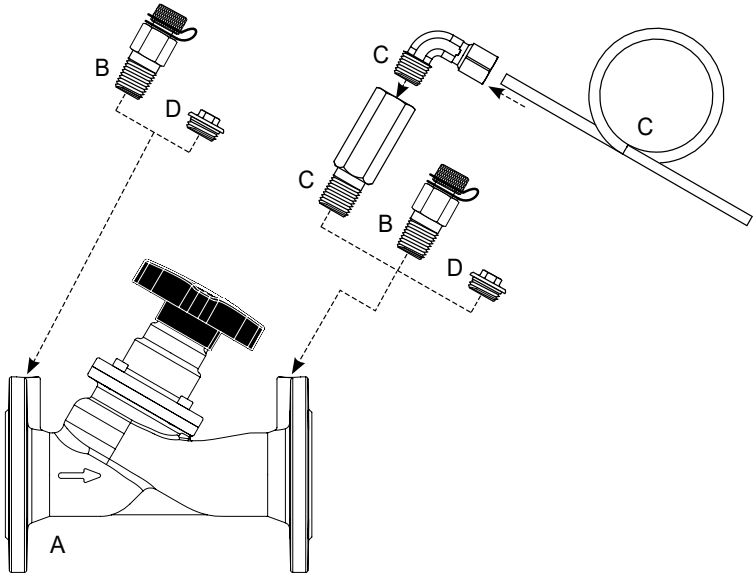

FlowCon International assumes no responsibility for mistakes, if any, in any printed material.